

Assembly Instructions For BUCNR Kicker

IMPORTANT HELPFUL HINTS. Read First!

- Read instructions through COMPLETELY before starting assembly.
- Always work on a clean, flat, solid, Level surface.
- ALL melamine edges MUST face front of unit.

Code	Description	Qty	4#25mm	
①	Support panel:486*120*16	3	A:25pcs	B:6pcs
②	Back panel A:851*150*16	1		
③	Right side panel:519*150*16	1	3*12mm	C:16pcs
④	Front panel A:867*150*16	1		
⑤	Front panel B:365*150*16	1	D:8pcs	
⑥	Back panel B:867*150*16	1		
⑦	Left side panel:519*150*16	1		

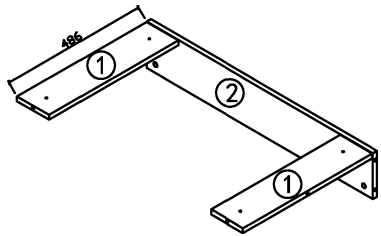

STEP 1

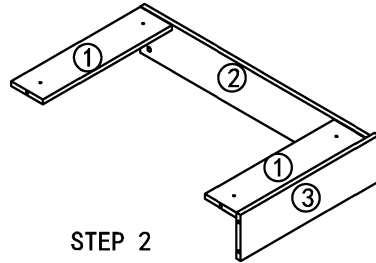

STEP 2

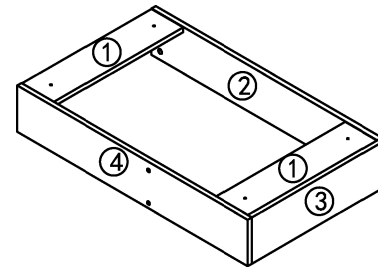

STEP 3

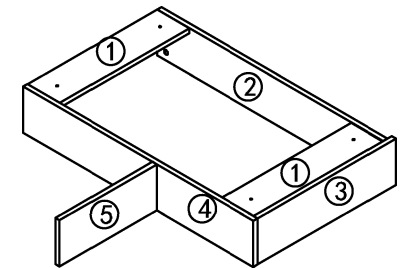

STEP 4

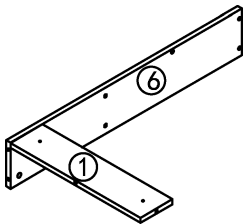

STEP 5

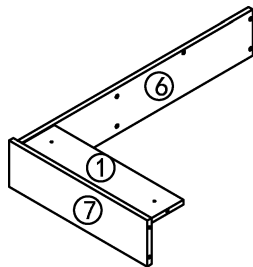

STEP 6

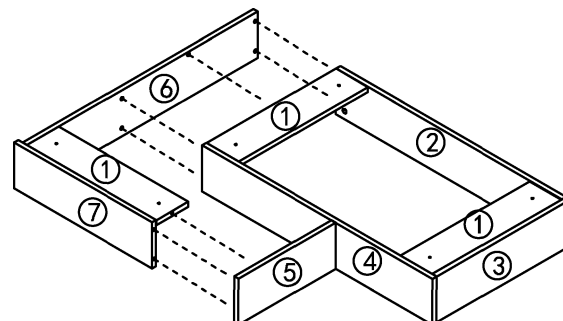

STEP 7

