



BD60

Draw Unit

60cm

FEATURES & BENEFITS

- Durable white high gloss finish to all sides
- Designed for easy installation
- Fully assembled (no assembly required)
- Soft closing drawers and doors
- Stylish chrome handles

SIZE

- 600mm W x 580mm D x 864mm H

COLOUR

- Gloss White

MANUFACTURING MATERIALS

- High Grade HMR (Highly Moisture Resistant) Board
- Durable 2 pack painted surface

GUARANTEE

- All Alpine cabinets come with a genuine 5 Year Warranty which covers materials used and workmanship at the time of manufacture.

Dimensions and set-outs are correct at the time of publication, however the manufacturer/ distributor takes no responsibility for printing errors.

The manufacturer/distributor reserves the right to vary specifications or delete models from their range without prior notification.

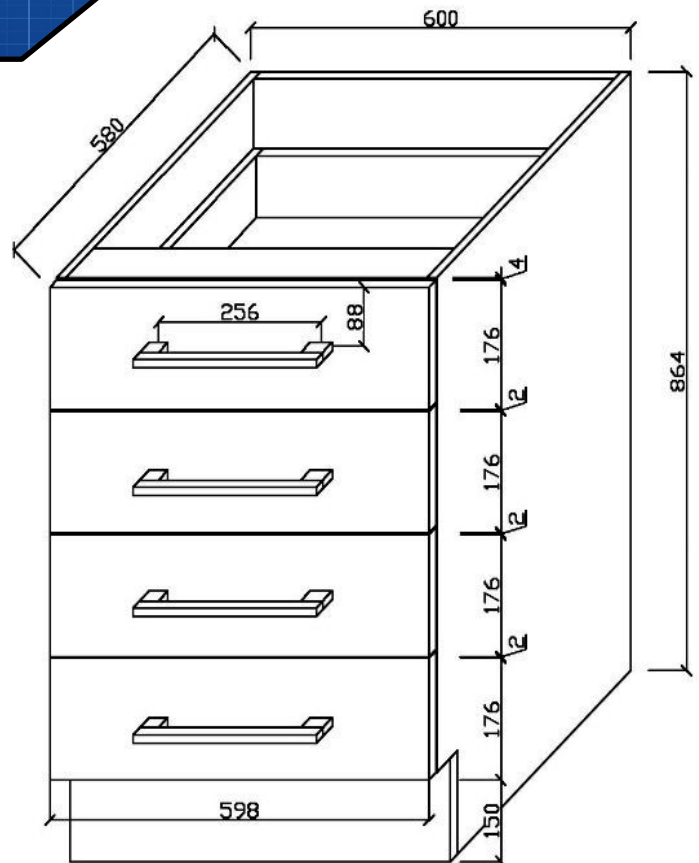

www.alpinekb.com.au